

# ***KMART***

## **INSTRUCTION MANUAL**

### **BICYCLE ASSEMBLY & MAINTENANCE**

**20”(50cm), 24” (60cm), 26” (66cm) & 700C(70cm)  
ADULT BICYCLE**

IMPORTANT NOTICE! Do not Return This Product To The Store, Please Keep Your Instructions! Your Model number is necessary should you need to contact us. Please read through this instruction manual book to familiarize yourself with all parts and assembly steps. Kindly refer to the parts identifier below and be sure that all parts have been included. Although we are dedicated to giving our customers the best product possible, a question may arise or parts may be missing. If you are missing parts, or, if you have any questions, please contact our fast and friendly service centre on: TEL: 1800-124-125

# TABLE OF CONTENTS

RULES OF THE ROAD	1
OWNER'S INFORMATION	1
OWNER'S IDENTIFICATION RECORD	2
SAFETY WARNINGS	3
SAFE SIZING OF A BICYCLE	4
TOOLS REQUIRED FOR ASSEMBLY	4
PUTTING YOUR BIKE TOGETHER	5
ASSEMBLE THE FRONT WHEEL TO FORK	5
KICKSTAND	5-6
REFLECTORS	6-7
HANDLEBAR STEM	8
HANDLEBAR	8
PEDALS	9
SEAT POST AND SEAT	9-10
SIDEPULL BRAKE	11
DISC-BRAKE	12-14
V-BRAKE	14
ABOUT YOUR DERAILLEUR	15
FRONT DERAILLEUR	15
REAR DERAILLEUR	16
GRIP SHIFTER	16
THUMB SHIFTER	17
QUICK RELEASE WHEEL	17
REAR SHOCK PRELOAD ADJUSTMENT	18
REAR SHOCK MAINTENANCE	18
SAFETY CHECK LIST	18
WHAT IS TORQUE?	19
MAINTENANCE	19-21
RULES OF SAFE CYCLING	22
REPLACED WITH FUTURE LOGISTICS DETAILS	23
WARRANTY STATEMENT	24

**NOTE: YOU COULD HAVE ADDITIONAL INSTRUCTIONS INCLUDED IN YOUR PARTS BAG THAT EXPLAIN THE OPERATION AND ASSEMBLY OF THE SHIFTERS, SHOCK FORK AND REAR DERAILLEUR, REAR AND KEEP THIS INFORMATION FOR FUTURE REFERENCE.**

**IT IS IMPORTANT TO READ THIS MANUAL THOROUGHLY  
BEFORE ASSEMBLING, RIDING, OR PERFORMING  
MAINTENANCE ON THIS BICYCLE.  
KEEP THIS MANUAL FOR FUTURE REFERENCE.**

# RULES OF THE ROAD

1. **IN THE INTEREST OF SAFER CYCLING, MAKE SURE YOU READ AND UNDERSTAND YOUR OWNER'S MANUAL.**
2. **NOTICE:** Some state and local traffic laws may require that your bicycle be equipped with a warning device, such as a horn or bell and a light, if the bicycle is to be ridden after dark.
3. Always ensure that appropriate footwear is worn whilst riding this bike. Lace up shoes with rubber soles, never ride barefooted or in sandals, and ensure that shoelaces are tied and kept out of the way of the wheels and drive system.
4. **CAUTION: WET WEATHER WARNING:** Check your brakes frequently. The ability to stop your bicycle is critical. Roads are slippery in wet weather so avoid sharp turns and allow more distance for stopping. Caliper brakes may become less efficient when wet. Leaves, loose gravel and other debris on the road can also effect stopping distance.
5. The kickstand is designed to support the bicycle only. Not the rider.
6. Replace bent or broken spokes, and bent or damaged wheel rims.
7. Obey all traffic regulations. Most traffic regulations apply to bike riders as well as automobile operators.
8. Follow the traffic flow in a straight line close to the curb. Watch for cars moving in and out of traffic.
9. Always ride alone. Never carry other riders. This is dangerous and it makes the bicycle harder to control.
10. When riding in pairs or in larger groups, from a single line along the right side of road. Set up a sensible distance between riders. Don't tailgate.
11. Always be alert. Animals or people may dart in front of you. Be on the alert. People have the right of way. Be alert to people opening car doors when passing parked cars. Your bicycle was not designed for stunting and experimentation. Enjoy riding it in a safe manner.
12. Be careful at all intersections. Slow down and look both ways before crossing.
13. Use hand signals. Always let other drivers and pedestrians know what you are going to do. Signal 100 ft(30.48 cm). before turning unless your hand is needed to control the bike.
14. **CAUTION: NIGHT TIME OPERATION:** We do NOT recommend riding your bike at night. If you have an emergency that makes it necessary to ride at night, have proper lights and reflectors. Do NOT ride at night without a headlight, taillight, a white front reflector, a red rear reflector and yellow wheel reflectors.
15. Do not carry packages or objects which obstruct vision.
16. Never hitch rides. Never hold onto moving vehicles while riding. Never Stunt.
17. **ON AND OFF ROAD OPERATION:** Avoid the following hazards: drain grates, pot holes, ruts, soft road edges, gravel, and leaves especially when they are wet.

## OWNER'S INFORMATION

Throughout this manual you will find **WARNINGS, CAUTIONS and NOTES or NOTICES.**

**WARNINGS:** Pay special attention to these since failure to do so could result in injury to the rider or others.

**CAUTIONS:** If not followed these could result in mechanical failure or damage.

**NOTES OR NOTICES:** These specify something that is of special interest.

Owner's information continued next page.

## **OWNER'S INFORMATION continued**

It is the responsibility of the person who initially assembles the bicycle to do so correctly and make any necessary adjustments for proper operations. The owner or principal rider is then responsible for normal maintenance of the bicycle to keep it in good condition.

1. Make certain that all assembly instructions and necessary adjustments have been followed.
2. Perform the safety check list and mark each item listed.
3. Know how to operate all standard and accessory equipment on the bicycle.
4. Make certain that anyone who uses the bicycle has been fully instructed in its operation.
5. If your bicycle was obtained assembled, we recommend that you review the complete assembly instructions and perform checks specified in this manual before riding the bicycle.

## **OWNER'S RECORD**

Keep this information as a permanent record

In the event of theft or loss, your law enforcement agency will require this information for identification purposes.

The same information will be required when ordering parts and service.

Serial number: \_\_\_\_\_

Wheel Size (On tire sidewall): \_\_\_\_\_

Model Number: \_\_\_\_\_

Color of bike: \_\_\_\_\_

Name of bike (On top tube or chain guard ): \_\_\_\_\_

Date purchased: \_\_\_\_\_

Where Purchased: \_\_\_\_\_



## SAFETY WARNINGS

Before you ride, please read all the following items making sure you understand them. Failure to do so could cause damage to the bicycle or possible injury to yourself or others. Your bicycle meets or exceeds industry standards. It is NOT designed for off-road use, Jumping, stunts and other types of abusive riding.

### BRAKE PRECAUTIONS

1. Do not ride the bicycle until you have checked for proper brake adjustments See “Hand brake lever Assembly” and “Caliper Brake Adjustment” Sections.
2. When riding your bicycle of the first time. Test the brakes at a slow speed on a large level surface without obstructions. Also, never attempt to stop suddenly using the front brake only, as this could throw the rider off the front of the bicycle.
3. Check and adjust the brakes, if necessary, at the first sign of failure. This will enable the rider to make a quick and smooth stop. On caliper brakes, if a brake lever touches the grip when it is squeezed, adjust the brakes.
4. Going downhill fast is dangerous since you can't stop nearly as fast as you can on level around. A curve at the bottom of a hill could force you into oncoming traffic or off the road if you are going at an excessive speed.
5. Use the front brake slowly and carefully, especially while turning or when the road is wet or covered with gravel, sand or leaves. Start braking sooner under these conditions and with less force to reduce the chances of skidding. Wet brake shoes mean that it will require more distance to stop. Start braking sooner than normal in wet conditions.
6. Nighttime riding:
  - a. You can't see the controls on your bicycle at night so you must know where they are by touch.
  - b. Slow down. Debris and holes are much harder to see at night.
  - c. If possible, ride on streets that are familiar to you. Terrain that you have never seen during the day is dangerous at night.
  - d. Use well lighted streets whenever possible. Avoid unlighted bike paths.
  - e. Comply with all legal requirements in your state. You should at least have a “white light”. (not just a white reflector) On the front and a rear red reflector. All states require that lamp be used that emits a white light.
  - f. Children generally should not be allowed to ride a bicycle at night or during periods of low visibility such as dawn, dusk or bad weather. Adults should avoid night riding if possible.
  - g. It is a good idea day or night to wear a helmet and have a rear view mirror.
7. If the stem is not inserted into the head tube to at least the minimum insertion line, it is possible to over-tighten the handlebar stem bolt and damage the fork stem body. This could cause an unsafe condition and risk injury to the rider.
8. For safe operations, you must secure the pedal spindle tightly against the crank arm with a wrench that fits the shoulder of the pedal spindle. This is important: it avoids stripping threads. Always replace damage pedals.
9. When adjusting the seat height, you must have the minimum insertion mark on the seat post inserted inside the frame.

## SAFE SIZING OF A BICYCLE

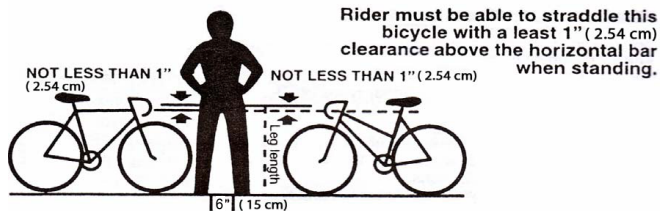

The correct frame size is the largest frame that the rider can automatically straddle keeping both feet on the ground and allowing 25 mm (1 inch) clearance between the rider's crotch and the top of the frame tube (see illustration) Noted Ladies can use men's bicycle to determine their correct frame size.

Rider must be able to straddle bicycle with at least 1 inch (2.54cm) clearance above the horizontal bar when standing.

### UNPACKING

Important: Remove the bicycle and all parts from the carton. Lay out all unassembled parts and **READ THE ASSEMBLY INSTRUCTIONS** In this manual before assembling our bicycle. The instructions are a step by step procedure. Follow the steps that pertain to your model.

**NOTE:** Your bicycle may be equipped with a different component than the one illustrated. However, the procedure for assembly or adjustment is basically the same.

### RECORD SERIAL NUMBER

Note: This information is only available on the bicycle itself. Be sure to keep your own record of this number. Each bicycle has a serial number stamped into the bottom of the frame or on the head tube. (See illustration) Record this number on page 2 of your owner's manual to keep it for future reference.

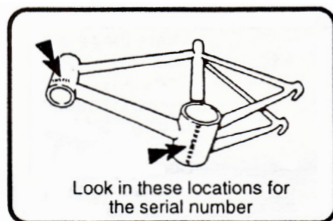

### TOOLS REQUIRED FOR ASSEMBLY

7mm Phillips screw driver

7mm flat edge screw driver

Standard slip joint pliers

hammer

Torque Wrench Set

2 in 1 of 5mm & 6mm Allen wrenches and open end set of metric flat wrenches 6" (15 cm) and 10" (25.4 cm) Adjustable wrench (Or Open End Set Of Metric Flat Wrenches). These tools should be available to perform the basic steps of assembling the bicycles. They can also be used to make maintenance adjustments outlined in this manual. Special tools are required to disassemble chain, remove the rear hub parts and true wheels. Special tools are not required for assembly and normal maintenance.

**NOTE:** Use a hand or foot pump to inflate tires. Never inflate tire with an air compressor at a gas station. **WARNING: IMPROPER INFLATION IS THE BIGGEST CAUSE OF TIRE FAILURE. DUE TO THE SLIGHTLY POROUS NATURE OF BICYCLE INNER TUBES, IT IS NORMAL FOR YOUR TIRES TO LOSE PRESSURE OVER TIME. FOR THIS REASON, IT IS CRITICALLY IMPORTANT TO MAINTAIN THE PROPER TIRE INFLATION ON YOUR BIKE.**

Many bicycles are sold unassembled in cartons. For these bikes it is the responsibility of the owner to make sure the assembly instructions in this book are followed exactly. For bicycles that are purchased in an assembled condition, it is the responsibility of the owner to carefully check and test the bike. The bicycle product does not provide above tools.

# PUTTING YOUR BIKE TOGETHER

## REMOVE BIKE FROM CARTON

Be sure all parts are removed from carton. Check before you discard the carton. Remove all protective packing material.

### STEP # 1 – ASSEMBLE THE FRONT WHEEL TO FORK

1. Turn the fork until the fork Plate points to the front of the Bicycle. (See illustration A)
2. Insert the wheel into the fork.
3. Install an axle nut to each side of the axle. (see illustration B)
4. Tighten the axle nuts by hand. Make sure there is an equal distance between each fork tube and the wheel. Then use a wrench and securely tighten the axle nuts. (See illustration C & D)

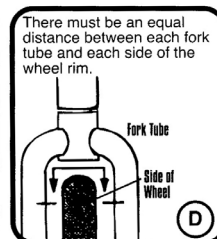
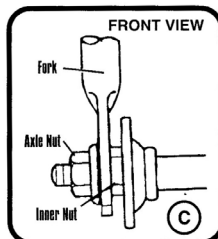
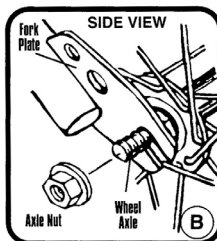
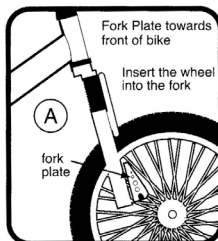

**TORQUE REQUIREMENTS  
(SEE PAGE 19)**

### STEP # 2 KICKSTAND

**TYPE 2A - NOTE: FOR YOUR CONVENIENCE, YOUR KICKSTAND MAY BE PREASSEMBLED AT THE FACTORY.**

1. Place the right side (sprocket side) of the bike against a wall or have someone hold the bike for you.
2. Remove the rear axle nut and washer from the left side rear wheel.
3. Slide the kickstand plate onto the axle, so that it is seated against the rear dropout.
4. Slide the washer and nut back onto the axle and tighten securely.
5. Leave the kickstand leg down so it will support the bike during the rest of the assembly process.

**CAUTION: THE KICKSTAND IS DESIGNED TO SUPPORT THE BICYCLE ONLY, NOT THE BICYCLE AND RIDER.**

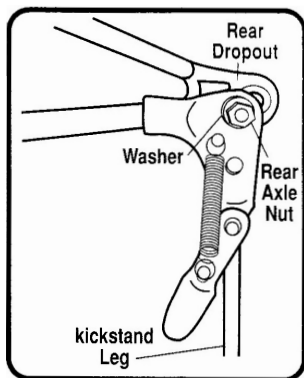

**TYPE 2B - NOTE: YOUR KICKSTAND MAY BE PREASSEMBLED AT THE FACTORY. IF SO, PLEASE PROCEED TO STEP 4.**

1. Place the bicycle in an upright position.
2. Remove the top plate from the kickstand.
3. From the left side of the bicycle side of the bicycle (opposite side from chainguard), place the kickstand in position beneath the two rear fork legs.
4. Place the top plate, flange down, onto the mounting bolt.
5. Replace the washer and nut onto the mounting bolt. Hold the kickstand arm in an up position aligned with the frame stay, then securely tighten the mounting bolt.
6. Leave leg of kickstand down so it will support the bicycle during the rest of the assembly.

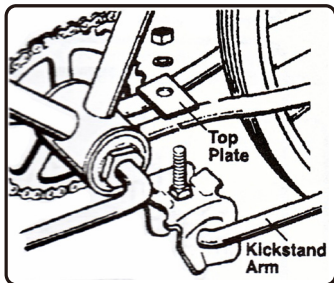

**WARNING: THE KICKSTAND IS DESIGNED TO SUPPORT THE BICYCLE ONLY; NOT THE BICYCLE AND THE RIDER.**

### **STEP# 3 FRONT (WHITE) REFLECTOR**

**TYPE 3A - NOTE: For your convenience, your front reflector may have been pre-assembled to the handlebar at our factory.**

1. Remove the clamp screw from the reflector bracket.
2. Push open the bracket "loop" and slide it onto the handlebar (If there is a sizing insert included with the bracket, please be sure it is inside the clamp loop before mounting.)
3. Position the reflector bracket on the handlebar between the grip and crossbar, about 5" (127cm) from the end of the handlebar.
4. Tighten clamp screw securely.

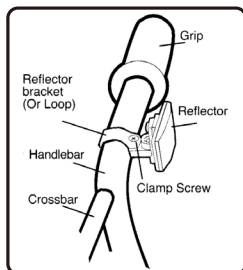

**CAUTION:** Be sure the reflector is in the same longitudinal plane as the bicycle (horizontal to the ground). If the reflector is aimed up or down, oncoming headlights may not reflect properly in the reflector. If the reflector is not horizontal to the ground, loosen the clamp screw and readjust the angle. Tighten clamp screw securely.

### **TYPE 3B**

1. Remove the clamp screw from the reflector bracket.
2. Push open the bracket "loop" and slide it around the stem neck. (If there is a sizing insert included with the bracket, please be sure it is inside the clamp loop before mounting.)
3. Position the reflector so that it faces the front of the bike and does not interfere with the operation of the bike in any way.
4. Tighten clamp screw securely.

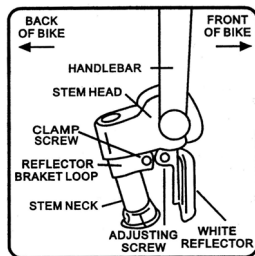

**CAUTION:** Be sure the reflector is in the same longitudinal plane as the bicycle (horizontal to the ground). If the reflector is aimed up or down, oncoming headlights may not reflect properly in the reflector.



If the reflector is not horizontal to the ground, loosen the adjusting screw and readjust the angle. Tighten adjusting screw securely.

#### STEP# 4 REAR (RED) REFLECTOR

For your convenience, your rear reflector may have been preassembled at the factory.

**NOTE :** It is important to check and adjust the position of the reflectors as you assemble your bike. The reflectors must always be vertical (perpendicular to the ground) and pointed toward the front and rear of the bike. Please make sure that the adjustment is correct as a final step in the assembly of your bike.

1. Put the seat post mounted rear reflector in the correct position by loosening the screws of the rear reflector bracket.
2. Make sure the rear reflector is vertical to the ground and points straight back.
3. Make sure there are at least 3 inches (7.62 cm) of clearance between the top of the seat and the top of the red rear reflector.

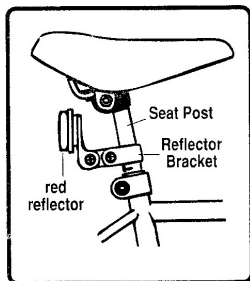

#### STEP# 5 WHEEL REFLECTORS

**NOTE :** FAILURE TO MOUNT AND DISPLAY THE REFLECTORS SUPPLIED COULD CONSTITUTE A VIOLATION OF THE LAW WITH YOUR CITY OR STATE FOR YOUR SAFETY. PLEASE MOUNT ALL REFLECTORS AS INDICATED. FOR ADDITIONAL NIGHT RIDING SAFETY AND TO COMPLY WITH THE LAWS OF MANY CITIES AND STATES, YOUR BIKE SHOULD BE EQUIPPED WITH HEAD AND TAILLIGHTS. FOLLOW INSTRUCTIOS ACCORDINGLY. YOU WILL RECEIVE EITHER TYPE A OR TYPE B WHEEL REFLECTORS.

##### TYPE 5A (may already be assembled)

1. Position the reflector between the left and right layers of spokes opposite the valve stem.
2. Then slide notch in circle of reflector onto spoke slide the reflector as close to the wheel rim as possible without bending spokes.
3. Push slot in white cap over spoke so the flanges fit into large slots in circles. Twist white cap towards the right with a flathead screw driver as far as possible. Reflector should be secure.

**NOTE:** When assembled, the distance from the center of the reflector to the inside of the wheel rim must be less than 3" (7.62cm).

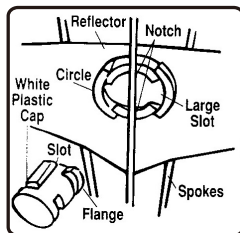

##### TYPE 5B (may already be assembled)

1. Position the reflector between the left and right layers of spokes opposite stem valve.
2. Slide notch in circle of reflector onto spoke and slide reflector as close to wheel rim as possible without bending spokes.
3. Attach with screw and hex nut supplied with reflector.

**NOTE :** When assembled, the distance from the center of the reflector to the inside of the wheel rim must be less than 3" (7.6 cm).

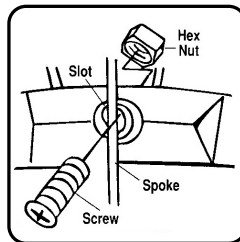

## STEP# 6 STEM ASSEMBLY

1. Insert the stem pillar into the fork tube to the minimum insertion line, indicated on the stem pillar.
2. Tighten the 6 mm stem pillar bolt to a torque requirement of 12-15 ft. lb. or 17-19 NM.

**WARNING:** The handlebar stem pillar must be inserted into the head tube until the minimum insertion line indicated on the stem is covered.

3. Face the handlebar stem forward directly in line with the front wheel.
4. Tighten the two 5 mm Allen screws on the handlebar stem to 7 ft. lb. or 10 NM.

**WARING:** THE ASSEMBLER IS CAUTIONED AGAINST THE DANGER OF DAMAGING THE HANDLEBAR STEM PILLAR ASSEMBLY AND POSSIBLE INJURY TO RIDER IN OVERTIGHTENING THE STEM PILLAR BOLT.

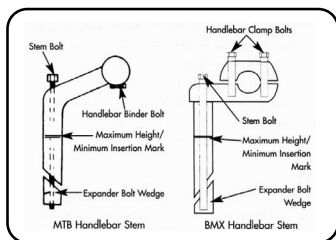
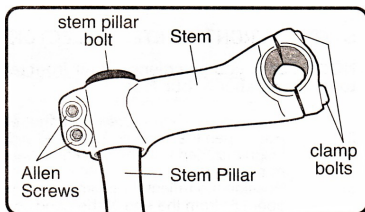

## STEP# 7 ASSEMBLE HANDLEBAR

**NOTE:** Your handlebar has been pre-assembled to the stem at our factory. Please use the following information if you need to adjust the angle.

**WARNING:** For safe operation, the clamp bolts must be securely tightened.

1. Loose clamp bolts with an Allen wrench.
2. Adjust handlebar to desired angle.
3. Securely tighten clamp bolts. (Recommended torque is 15 ft. lbs or 17-19 Newton Metres)
4. Check handlebar for tightness. If you can move it forward or backward, the clamp bolts are not tight enough.
5. Check steering by straddling the front heel and trying to turn the handlebar. If you can turn the handlebar without turning the front wheel, the stem is too loose. Line up handlebar with front wheel. Retighten the stem pillar bolt as instructed in step 4.

**WARNING:** HANDLEBAR GRIPS OR TUBE END PLUGS SHOULD BE REPLACED IF DAMAGED, AS BARE TUBE ENDS HAVE BEEN KNOWN TO CAUSE INJURY. IT IS PARTICULARLY IMPORTANT THAT BICYCLES USED BY CHILDREN BE CHECKED REGULARLY TO ENSURE THAT ADEQUATE PROTECTION FOR THE ENDS OF THE HANDLEBARS ARE IN PLACE.

## STEP # 8 INSTALL PEDALS

**WARNING:** For safe operation, the pedal spindle must be securely tightened against the crank arm. Always replace damaged pedals, and always wear shoes or sneakers when riding a bicycle.

**NOTE :** Start each pedal spindle by hand to avoid stripping the threads.

1. Look for the letters "R" or "L" stamped on the pedal spindle.
2. Thread the pedal marked "R" into the crank arm on the "chain side" of the bike. Turn the pedal spindle in a clockwise direction. Securely tighten the pedal spindle.
3. Thread the pedal marked "L" into the crank on the left side of the bike. Turn the pedal spindle in a **COUNTERCLOCKWISE** direction. Securely tighten the pedal spindle.

**NOTE:** Both pedals should be tightened towards the front of the bicycle.

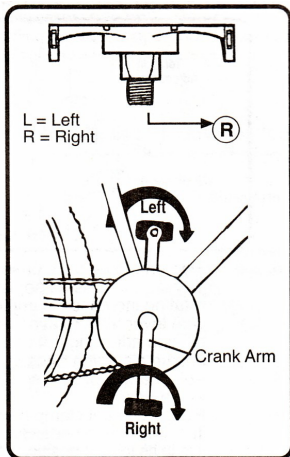

**TORQUE REQUIREMENTS** 18-20 ft-1 bs or 20-26 Newton Netres.

## STEP # 9 INSTALL SEAT POST AND SEAT

**NOTE:** your saddle has been pre-assembled to the seat post at our factory. Please use this information for adjustment and future reference.

1. Loosen seat clamp nuts.
2. Insert the top portion of seat post into the seat clamp. Be sure seat post is completely inserted into the seat clamp and butted tightly against the end stop.
3. Retighten seat clamp nuts on both sides (Hand tight). These nuts will be tightened later with an adjustable wrench.
4. Insert seat post into bicycle frame. Be sure that seat post is inserted into frame at least 2 1/2" (65mm).

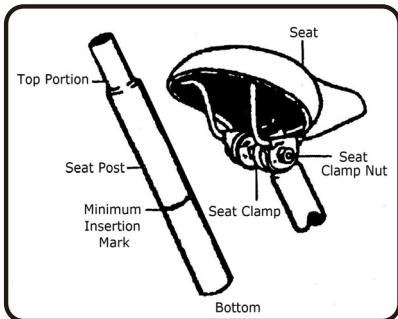

**CAUTION: MINIMUM INSERTION LINE SHOULD BE COMPLETELY INSERTED INTO FRAME AND NOT VISIBLE.**

## STEP # 9 SEAT POST AND SEAT continued

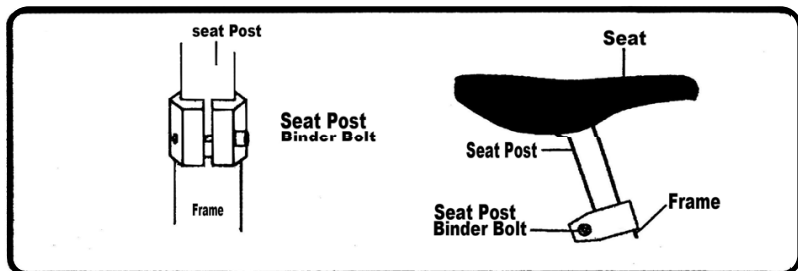

5. Tighten seat post binder bolt securely at desired height.
6. Adjust angle of seat so that top of seat is parallel to the ground or comfortable to the rider.
7. Retighten seat clamp nuts securely with an adjustable wrench.

**NOTE :** Test the seat to pedal distance by having the rider sit on the seat. When the rider's leg is lightly bent, the ball of the foot should rest on the pedal when it is in its lowest position. If it does not, adjust the seat height as necessary. Check for tightness by attempting to twist the seat. If the seat is loose, be sure to tighten the clamp nut and binder bolt nut securely.

**TORQUE REQUIREMENTS (SEE PAGE 19).**

### IF YOUR BICYCLE HAS A QUICK RELEASE SEAT POST:

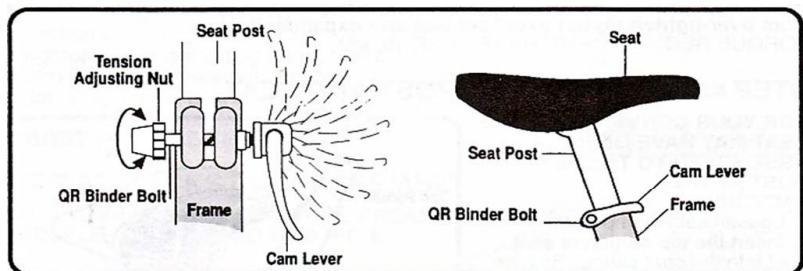

5. Tighten the quick release seat post binder bolt securely at desired height. Turning the tension adjusting nut clockwise while keeping the cam lever from rotating increases clamping force, turn it counterclockwise while keeping the cam lever from rotating reduces clamping force. Less than half a turn of the tension adjusting nut can make the difference between safe clamping force and unsafe clamping force.
6. Adjust angle of seat so that top of seat is parallel the ground or comfortable to the rider.
7. Retighten seat clamp nuts securely with an adjustable wrench.

**NOTE :** Test the seat to pedal distance by having the rider sit on the seat. When the rider's leg is slightly bent, the ball of the foot should rest on the pedal when it is in its lowest position. If it does not, adjust the seat height as necessary. Check for tightness by attempting to twist the seat. If the seat is loose, be sure to tighten the clamp nut and binder bolt nut securely.

**TORQUE REQUIREMENTS (SEE PAGE 19).**

## STEP# 10 - IF YOUR BIKE HAS A SIDEPULL BRAKE FOLLOW THESE INSTRUCTION.

**WARNING:** The handbrakes on this bicycle were NOT adjusted at the factory. Before you ride this bicycle you must assemble and adjust the hand brakes.

The brake levers are pre-assembled. The right side of the handle bar is for the front brake and the left side of the handlebar is for the rear brake.

1. Insert the barrel end of the brake cable into the hole in the brake lever. (See illustration A) Squeeze the rear brake arms with your hand until the brake rubbers are up against the wheel rim. This will enable the inner brake cable wire to be loose, and have enough space for you to easily slip the barrel end of the brake cable wire into the hold in the brake lever.
2. Next, pull the brake cable wire through the key hold slot the front of the brake lever (See illustration B) and then remove your hand. The brake cable cap will automatically spring back into the slotted key hole on the front of the brake lever assembly. (see illustration C)
3. Next, proceed to adjust the hand brake.
  - (a) Loosen the cable fixing bolt.
  - (b) Again squeeze the rear brake rubbers against the wheel rim.
  - (c) Pull the brake cable wire through the fixing bolt hole until there is no slack in the brake wire.
  - (d) Tighten the cable fixing bolt.
  - (e) Squeeze the brake lever hard and then release several times. Rotate the rear wheel, be sure the rear wheel is straight and does not wobble. The brake rubbers should not touch the wheel rim, and there should be about 1/16 inch (1.6mm) clearance between the wheel rim and each brake rubber.

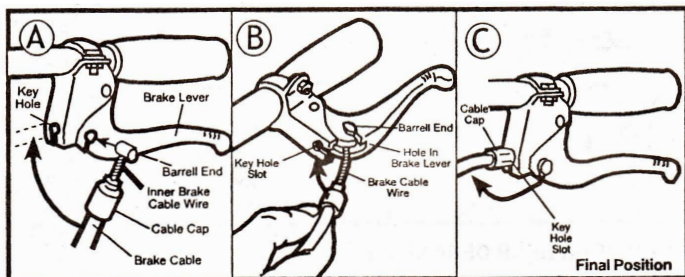

**NOTE:**  
The  
right lever controls the  
front brake and the  
left lever controls the rear  
brake.

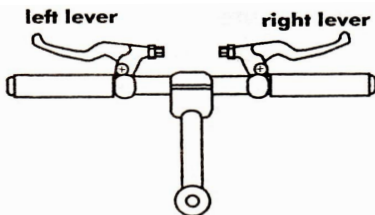

## IF THE BRAKE RUBBERS TOUCH THE WHEEL RIM

Loosen the anchor bolt nut and let the brake rubbers spring open a little, to clear the wheel rim. Retighten the anchor bolt nut and squeeze and release the brake lever. Check the clearance again. Repeat the adjustment if necessary.

**NOTE:** If additional brake adjusting is required – you can bring the brake rubber closer to the wheel rim by turning the adjusting screw counterclockwise. To move the brake rubbers further from the rim, turn the adjusting screw clockwise. Be sure the cable is locked securely through the anchor bolt. (See illustration D). Reset cable adjuster lock nut when adjustment is final.

**WARNING:** If after brake adjustments are made, and the hand brake still does not function, then have brake repaired or adjusted at a bicycle service shop. Do not ride if brakes do not function properly.

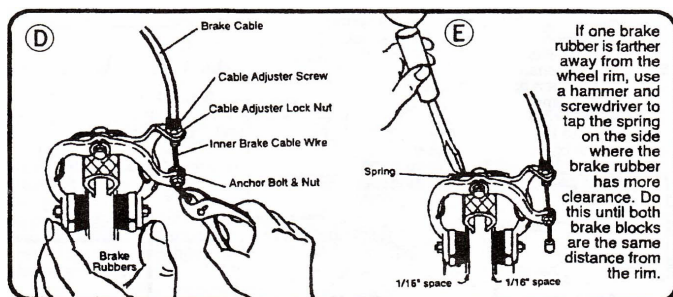

## IF YOUR BIKE HAS DISC-BRAKE OR V-BRAKE

**WARNING:** These brakes are highly sensitive and extremely powerful. Before using your new brakes, be sure that you are completely familiar with their operation. Practice your riding and braking techniques on a flat level surface at slow speeds prior to attempting any high speed or off road maneuvers.

### DISC-BRAKE INSTALLATION

**NOTE:** Your Disc-brakes have been pre-installed at the factory, use this information for adjustment and future reference.

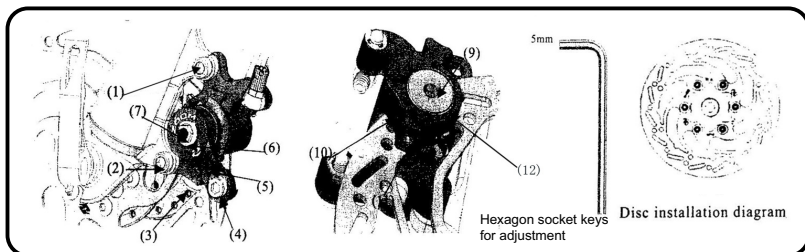

- |                             |                           |                    |
|-----------------------------|---------------------------|--------------------|
| (1) (2) Horse screws        | (6) Adjusting pole        | (10) Brake boby    |
| (3) Interlocking screw pair | (7) Gland nut             | (11) Set screw     |
| (4) Handlebar screw         | (8) Support               | (12) Lining member |
| (5) Handlebar               | (9) Outer adjusting screw |                    |

1. Mount the discs
  - a. With the arrow of the brake disc forwards. use six M5x12mm disc screws to mount the discs to the hub respectively.
  - b. Fasten each of interlocking screw pairs with a torque of 8Nm/70in-lbs(3mm hexagon socket key).
2. Mount the wheel set
 

After fastening the brake discs to the hub, assemble the wheel set to the front fork or rear frame and fasten the axis.
3. Mount the disc brake system.
  - a. Mount the disc brake support to the front fork or rear fork tip.
  - b. Fasten the two M6\*P1.0 horse screws with a torque of 15Nm/130in-lbs(5mm hexagon socket key)
  - c. Thread the brake cable through Philip's head hollow screw of the disc brake and nut of the handlebar locking cable, Tighten the brake cable. Use 5mm hexagon socket key to fasten the handlebar screw.(if the test brake efficiency is ok, carry out step 4).
  - d. Use 5mm hexagon socket key to adjust the outer adjusting screws clockwise in order to obtain a good brake force of the brake lining members. Thus, the all installation steps of the disc brake are completed
4. Riding test:
 

In order for the disc brake and the brake discs to generate a good brake effect, use brake disc to rub against brake lining members for 1~30 times during the first riding test to increase brake efficiency. If the brake efficiency is still insufficient, go back to Item D of step 3 to adjust the distance of the lining members.
5. Maintenance:
 

After a long time riding of the bicycle, the lining member efficiency would become weak. You must adjust inner and outer lining of the disc brake or replace them with new ones to make their function optimal.

  - a. Refer to Item d of step 3 for adjustment of the lining member.
  - b. Replacement of the lining members:
    - 1) Remove the wheel set
    - 2) Use 5mm hexagon socket key to remove the outer adjusting screw and lining member

- 3) Use hexagon socket key to remove the inner lining member.
- 4) Use hexagon socket key to mount new lining members and adjust the distance between lining members and discs.
- 5) Replace the wheel set and fasten the axis.

## V-BRAKE INSTALLATION

**NOTE: your V-brakes have been pre-installed at the factory, use this information for adjustment and future reference.**

Install the v-brakes onto the cantilever bosses:

1. Slide each V-Brake assembly onto the appropriate cantilever boss and secure by tightening the cantilever bolt with a 5 mm hex key. You may hand tighten at this point as you will need to readjust the tension later. (See illustration A)
2. Install the inner brake cable by pushing it through the cable routing tube (or "noodle") note that we offer two noodle angles (90 degrees and 135 degrees) depending on your bike setup. Now tighten the cable fixing bolt to a torque that does not exceed 9-12 ft. -lbs. (See illustration B)
3. To ensure maximum leverage the two brake arms must be nearly parallel to each other. To make this adjustment, hold the brake shoes so that they are touching the rim and measure the distance between points a and b. (See illustration C)
4. Adjust the spring tension in each brake arm so that both sides are equally tensioned. Do this by holding the cantilever bolt with a 5mm hex key and turning the spring tension nut with a 23mm spanner. (See illustration D)
5. After ensuring that the total clearance between both brake pads and the rim is 2-3mm stretches the cable by squeezing the brake lever 5-10 times. (See illustration E) Then readjust the brakes as necessary.

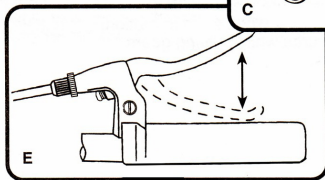
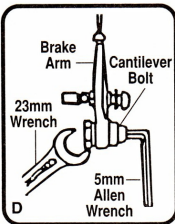
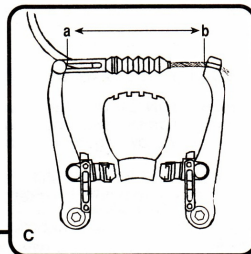
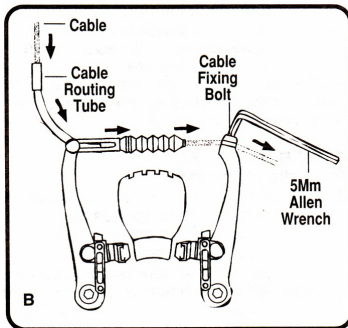
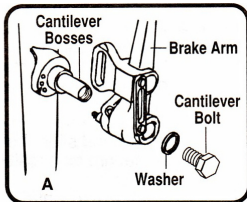



## STEP # 11 ABOUT YOUR DERAILLEUR

**OPERATION OF DERAILLERS:** Changing gears gives you more efficient pedaling effort. Too much pressure means change to lower gear. If pedaling is too easy, change to a higher gear.

**CAUTION:** don't force the shifter. Shifters should move easily and the chain should move easily from one sprocket to another. Please observe the following when shifting.  
Reduce pedaling pressure while shifting.

Shift only when pedals & wheels are in motion.

Never pedal backwards while shifting gears.

Never force shifters.

### HOW IT WORKS

When the right shift lever is shifted, the pulley guide or derail the chain allowing it to move to a different sprocket in the rear sprocket cluster. The derailleur cage is spring loaded. It keeps the chain tight, but gives as the chain moves from one sprocket to another.

### MAKING ADJUSTMENTS

#### FRONT DERAILLEUR ADJUSTMENT (PROCEDURE TO ALIGN CHAIN GUIDE)

1. Loosen mounting bolt(s) and position chain guide to within 3.2 mm (1/8inch) to 6.4 mm(1/4inch) above largest sprocket.
2. Re-tighten mounting bolt(s).

Refer to derailleur illustrations for locations of the **LOW and HIGH ADJUSTING SCREWS** on your type.

These adjusting screws are used to center the chain guide over each sprocket. If the chain guides are not centered, the chain will over-shift or fail to seat properly on front sprockets.

**PROBLEM:** Cannot shift into higher gear, or lower gear (depending on make of derailleur).

1. While rotating wheel with Pedals, place shift lever for Front Derailleur at the way to the rear.
2. Continue rotating wheel with pedals; adjust low gear adjusting screw until chain is centered on small front sprocket.
3. Loosen Cable anchor nut.
4. Pull end of cable wire and hold taut wire tightening cable anchor nut.
5. While rotating wheel with pedals, move shift lever forward Chain should shift to large front sprocket.
6. A fine adjustment can be made if necessary by turning the proper adjusting screw on the front derailleur so the chain derails onto the required sprocket.
7. The chain guide should derail the chain to the larger or smaller sprocket depending on type of derailleur.

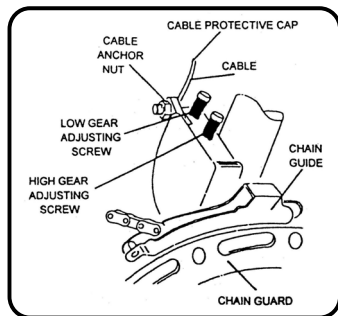
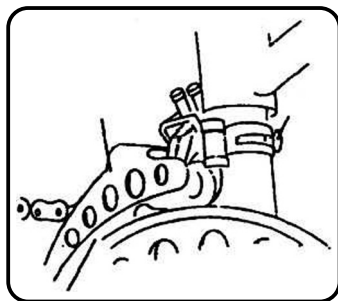

## REAR DERAILLEUR ADJUSTMENT

For your convenience. The derailleur has been pre-adjusted at the factory, but, due to jarring in shipment, it may need minor adjustments.

**WARNING:** Always move just one shift lever at a time to avoid damaging the derailleur. Please observe the following precautions.

Reduce pedaling pressure while shifting. Shift only when pedals and wheels are in motion.

Never back-pedal while shifting gears. Never force shift levers.

Don't let the chain slip off the largest cog during the pedaling, it would damage the REAR DERAILLEUR.

1. Rear wheel must be supported off the ground using a Bicycle stand, or place bicycle upside down resting it on the seat and handlebar. Cushion handlebars to prevent damage to stem stiffers and caliper brake lever.
2. Place shift lever for rear derailleur all the way to the rear. The chain should now be on the smallest sprocket high gear.
3. Check for slack in Cable at point A and tightness of the nut on the cable anchor bolt.

**NOTE:** The wire in the cable has a tendency to stretch after the bicycle has been ridden for a while.

If there is too much slack, the chain will not transfer to all speeds. If the cable wire is not taut, continue with STEP 4.

4. Loosen the nut on the cable anchor bolt.
5. Pull end of cable wire with pliers and hold while tightening cable anchor nut.
6. While rotating wheel with pedals, move shift lever backward and forward slowly. As the shift lever is moved toward the front, the derailleur moves toward the large rear sprocket low gear. As the shift lever is moved to rear, the derailleur moves toward the small rear sprocket high gear.
7. With the rear derailleur lever to rear in high gear, turn the "H" high gear adjusting screw until the rear derailleur pulley guide is in line under the freewheel small gear.

**NOTE:** When the "H" high gear adjusting screw is turned in a clockwise direction, the pulley guide moves toward the larger sprocket lower gear position.

8. Set rear derailleur lever to largest sprocket low gear position.
9. Check that the chain does not slip off the large sprocket.
10. If so, turn the "L" low gear adjusting screw in a clockwise direction until the chain does not slip off the larger sprocket when shifted.
11. If the chain is unable to reach the largest sprocket low gear. Or movement is difficult, then turn the "L" low gear adjusting screw in a counter-clockwise direction.

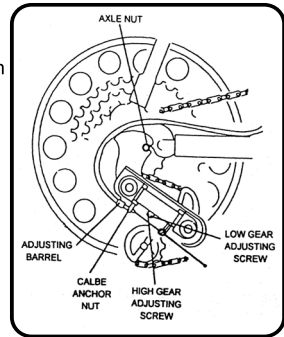

## GRIP SHIFTERS

### THE RIGHT SHIFTER

Operates the REAR derailleur and moves from HIGH gear to LOWER gears by twisting the grip TOWARDS the rider.

### THE LEFT SHIFTER

Operates the FRONT derailleur and moves from HIGH gear to LOWER gears by twisting the grip AWAY from the rider.

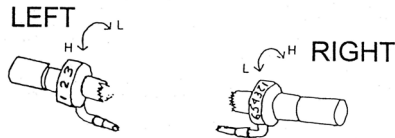

## THUMB SHIFTERS

### THE RIGHT SHIFTER

Operates the REAR derailleur and moves front HIGH gear to LOWER gears

### THE LEFT SHIFTER

Operates the FRONT derailleur and moves front HIGH gear to LOWER gears

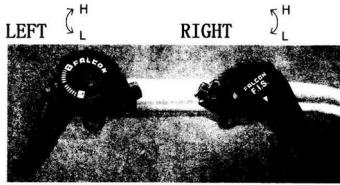

## STEP# 12 IF YOUR BIKE HAS QUICK RELEASE WHEELS QUICK RELEASE WHEEL INSTALLATION

**NOTE:** Some bicycles have wheel axles that incorporate a Quick Release(QR) mechanism. This allows easy wheel removal without the need for tools. The mechanism uses a long bolt with an adjusting nut on one end, and a lever operating a cam-action tensioner on the other.

1. To set, turn the lever to the open position so that the curved part faces away from the bicycle.
2. While holding the lever in on hand, tighten the adjusting nut by hand until it stops.
3. Pivot the lever towards the closed position. When the lever is halfway closed, there must be firm resistance to turning it beyond that point. If resistance is not firm, then further tighten the adjusting nut in a clockwise direction.
4. Continue to pivot the lever all the way to the closed position so that the curved part of the lever faces the bicycle.
5. The wheel is tightly secured when the serrated surfaces of the QR clamping parts actually begin to cut into the bicycle frame/fork surfaces.
6. Note that the same procedure applies when operating a QR seat post binder mechanism.

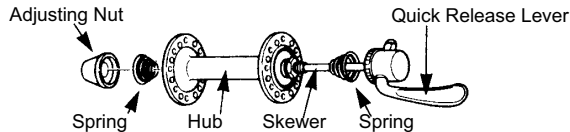
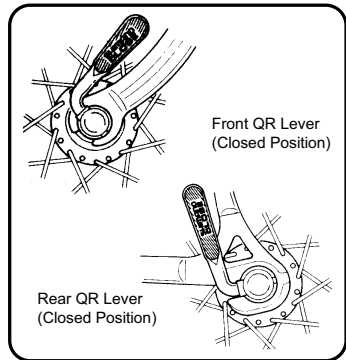

**WARNING:** Correct adjustment of the QR is vitally important to avoid an accident caused by loose wheels.

**WARNING:** Riding with an improperly adjusted wheel quick release can allow the wheel to wobble or disengage from the bicycle, causing damage to the bicycle, and serious injury or death to the rider. Therefore:

- a. Ask your dealer to help you make sure you know how to install and removed your wheels safely.
- b. Understand and apply the correct technique for clamping your wheel in place with a quick release.
- c. Each time, before your ride, check that the wheel is securely clamped.

## STEP# 13 IF YOUR BIKE HAS A REAR SUSPENSION REAR SHOCK PRELOAD ADJUSTMENT

The rear suspension unit on your bike has been set to provide superior function for nearly all riders. For optimum performance, however, the adjustable rear shock absorber should be correctly set for the riders' weight.

1. Adjust the spring preload collar of the shock by turning either clockwise or counter clockwise until it is positioned approximately at the midpoint of the threads.
2. Take a measurement (perpendicular to the ground) from the top of the saddle to the ground).
3. Sit on the bicycle in a normal riding position and have someone measure the distance from the top of the saddle to the ground as in step 2. The second measurement should 1/2" (1.27cm) shorter than the first. This compression of the suspension is known as "sag".
4. With no rider on the bicycle turn the spring preload collar to achieve the desired suspension sag. Turning the collar clockwise will reduce the amount sag and counter clockwise will increase the sag. After adjustment repeat steps 2 and 3 above until the proper sag is achieved. The front suspension unit is pre-set at the factory and requires no adjustment.



### SERVICE AND MAINTENANC FOR REAR SHOCK

Periodic lubrication for the rear shock will prolong the life and improve function. Service can be performed by the consumer and does not require any special tools.

#### WARNING: DO NOT ATTEMPT TO DISASSEMBLE THE SHOCK.

1. Before each ride check to be sure all mounting bolts are secure.
2. After 300 miles of use the bushings at either end of the shock should be lubricated with general purpose grease. Remove the shock mounting bolts and apply a small amount of lubricant on the bushing. Reinstall shock and make certain all bolts are securely tightened.
3. A light coat of grease can be applied to the outer threads of the shock body should the spring preload collar become difficult to turn.

## SAFETY CHECKLIST

Perform each check list below after all assembly instructions and any necessary adjustments have been completed. **Warning:** Failure to perform these checks could result in serious injury to yourself and others.

1. **STEERING:** Make certain that the stem is inserted into the head tube to at least the minimum insertion line. Check the clamp nut and stem bolt to make sure they are tightened securely. (See handlebar and stem assembly sections for recommended torque)
2. **BRAKES:** Check and adjust, if necessary (see brake assembly and adjustment section) **WARNING:** Before riding activate front and rear brakes 20-25 times then make final brake adjustments, this procedure take care of initial cable stretch.
3. **SEAT:** Check for tightness of seat clamp and seat post clamp and that the minimum insertion line is inside the frame. See that the seat is at the proper height for the intended rider.
4. **PEDALS:** Check pedal spindles making sure they fit tightly against the crank arms.
5. **TIRES:** Check and inflate, if necessary, using a hand pump. **NEVER INFLATE TIRES WITH AN AIRE COMPRESSOR AT A GAS STATION.** The correct pressure is marked on the side of the tire. **DO NOT OVERINFLATE.**
6. **GENERALL INSPECTION:** See that all reflectors have been properly installed. Replace any missing or damaged reflectors. Check all fasteners and tighten if necessary.
7. **TO THE RIDER OF THIS BIKE:** Make certain that you know how to operate the bike. We recommend that you read all safety and warning information in the manual before riding.

## WHAT IS TORQUE?

**IMPORTANT:** Torque is a measurement of how tight a fastener needs to be. A person using a 12 inch (30.5cm) wrench and applying one pound of force at the end of the handle, puts one foot-pound (ft.-lb.) of torque on a fastener. Torque can be measured with a torque wrench. Torque wrenches are available at most stores that have hand tools.

The ranges of torque in this chart cover many different parts from different manufacturers. To determine the torque value for a part, use the following as a guide.

- Torque nuts to the lowest value specified in the range.
- If the part continues to move, increase the amount of torque by half the difference from the present torque and the top of the torque range (an increase of 1 or 2 foot pounds between each test is the best procedure).
- If parts start deforming, stop tightening.

DO NOT under tighten fasteners. Part may slip or fall to function.

DO NOT tighten the fasteners too tight. You may damage the thread, which may cause an accident.

TORQUE REQUIREMENTS PART TO BE TIGHTENED	SUGGESTED TORQUE
Front Axle Nut	(22-27 Newton Metres)
Handlebar Clamping Bolt	(17-19 Newton Metres)
& Nut Stem Expander Bolt	(17-19 Newton Metres)
Seat	(12-17 Newton Metres)
Seat Post Binder Bolt	(15-19 Newton Metres)
Rear Axle Nut	(24-29 Newton Metres)
Brake Cable Fixing Nut	(7-11 Newton Metres)
Brake Caliper centre bolt nut	(12-17 Newton Metres)
Cotterless Crank nut	(27 Newton Metres)
Pedals	(20-26 Newton Metres)

## MAINTENANCE

### RECOMMENDED GENERAL MAINTENANCE SCHEDULE

To maintain the original brilliant plated and chrome finish, keep the bicycle and dry. Wipe off dirt moisture and oil clean, soft cloth, periodically polish with clear coat of wax.

**WARNING:** Do not use a wax of any kind on the rims of your bicycle. In order for the caliper brakes to operate properly, the rims should be kept clean and free of dirt and lubricants.

Due to wear of new parts, we recommend that you inspect the bicycle frequently for adjustment of brakes, bearings, wheels, etc. Adjust or tighten nuts and screws. The frequency of inspection would depend on how much and how hard you ride. Normally, we recommend a service check at least annually. Any component that does not function properly should be checked and corrected immediately. If you do not feel qualified to make the adjustment, we recommend that you take your bike to a qualified bicycle repairman.

Your bicycle will require maintenance. Although simple in most cases, there are times when the repairs and adjustment take special knowledge and proper tools. We recommend that when service is required. You should have a qualified bicycle repairman do it for you.

### FRONT WHEEL REMOVAL

TOOLS REQUIRED – 6" (15CM) AD. JUSTABLE WRENCH

- Place bicycle upside down, resting it on the seat and handlebar. If necessary, remove one caliper rake shoe to allow clearance for wheel removal.
- Remove axle nuts and depending on your model. Washer retainers or axle nuts, washers and wheel retainers.
- Remove wheel from fork.

**NOTE:** To assemble front wheel to fork, see front wheel assembly section.

## MAINTENANCE continued

### TIRE REMOVAL

Most tires can be removed and replaced by hand. Be careful, pinching the tire tube can easily put a hole in it even if you are using tire tools.

1. Remove valve stem cap.
2. Release air from the by depressing valve stem.
3. Tire should be loose in the rim.
4. Place wheel on floor.
5. Grasp tire with thumbs and fingers of both hands.
6. Lift tire and slide over one side of rim.
7. While holding the with one hand, peel tire off of wheel rim with other hand.

### TIRE INSTALLATION

1. Position tube inside of tire casing.
2. Insert tire valve stem into hold in rim.
3. With tube inside tire casing, roll tire casing onto rim. Be careful not to pinch tube, and be sure that the tube is not twisted in the tire.
4. Hold valve stem while inflating tire to pressure specified on side of tire.

### TIRE INFLATION *TOOLS REQUIRED – HAND PUMP & TIRE GAUGE*

Tires make a big difference in the performance of your bike. When properly inflated and maintained, your tires will give you many miles of wear and service. The following are tips for proper maintenance and care of tires and wheels.

**WARNING: IMPROPER INFLATION IS THE BIGGEST CAUSE OF TIRE FAILURE. DUE TO THE SLIGHTLY POROUS NATURE OF BICYCLE INNER TUBES, IT IS NORMAL FOR YOUR TIRES TO LOSE PREEASURE OVER TIME FOR THIS REASON, IT IS CRETICALLY IMPORTANT TO MAINTAIN THE PREPER TIRE IN FLATION ON YOUR BIKE.**

1. Tire pressure is indicated on the sidewall of the tire.
2. Check your tire pressure before each ride by squeezing the tire between your thumb and fingers. It should feel very firm, but not hard, when you sit on your bicycle, the tire sidewalls should not compress very much under your body weight. Check your tire pressure at least once a week with a pressure gauge.
3. Use a hand or foot pump to inflate your tires. **NEVER** inflate your tires with an air compressor at a gas station. Air compressors release a high volume of air under great pressure. This much air can explode a bicycle tire and tube in a matter of seconds, and any may cause serious personal injury. **DO NOT LET CHILDREN INFLATE TIRE.**
4. A bicycle tire will wear out faster when underinflated. An overinflated tire can become unseated from the rim and blow out. Be cautious of both these inflation areas.

### RECOMMENDED TIRE PRESSURE

BMX	241-344 k.p.a. (35-50 p.s.i.)
MTB	276-448 k.p.a. (40-65 p.s.i.)
Road Touring	483-620 k.p.a. (70-90 p.s.i.)
Road Racing	755-862 k.p.a. (110-125 p.s.i.)
Hybrid/Crossbike	414-690 k.p.a. (60-100 p.s.i.)

### BEAD NOT SEATED OR OFF RIM

Deflate tire, seat bead with hands and partially inflate tire for inspection. If the bead is properly seated, inflate to recommended pressure.

### SEATING TIRE

After repairing or changing the tires, it is important that the tire is seated properly on the rim.

1. Run your fingers around the bead of the tire to insure it is inside the outer rim ridge.
2. Partially inflate the tire with a hand pump.
3. Inspect the tire to see that:
  - a) Valve stem is perpendicular to the rim.
  - b) Tire bead is properly seat inside the rim.
  - c) Spin tire to see if it is aligned straight on the rim.

### TIRE NOT ALIGNED

Partially deflate tire, align using hands. Inflate tire to recommended pressure.

### TRUEING WHEEL

Because this is difficult procedure, we suggest spoke adjustment be made by a qualified bicycle repairman.



## **TIRE AND TUBE DAMAGE**

To prevent tire cuts, ruptures, rim bruise and star breaks. Avoid rough streets and alleys having glass and other debris. Don't jump curbing. Crooked wheels cause chafing of tires as well as uneven tread wear. To prevent distorted tire casings, hand your bicycle up or turn it upside down when storing for long periods.

## **BEARING ADJUSTMENT & LUBRICATION**

There are several areas on the bicycle containing bearings that must be adjusted and/or lubricated. Proper maintenance in these areas will insure longer bearing life, and easier and safer riding. Adjustment of the bearings requires special knowledge and tools. We strongly suggest these adjustments be made by a qualified bicycle repairman.

## **BRAKE RUBBER REPLACEMENT**

The brake rubbers will be damaged or worn-out after long use. Loosen the anchor bolt nut and the rubber bolt nuts. Replace the damaged rubbers. Re-tighten the bolt nuts and then re-tighten the anchor bolt nut.

**WARNING:** Be sure the anchor bolt and the rubber bolts are fully tightened. Do not ride your bicycle if the rubber has been damaged or has worn-out.

## **FRONT FORK**

**WARNING:** IF YOU REPLACE THE FRONT FORK, MAKE SURE THE REPLACEMENT FORK HAS THE SAME RAKE AND SAME TUBE INNER DIAMETER AS THE ONE ORIGINALLY FITTE TO THE BICYCLE

## **LUBRICATION AND CLEANING**

**WARNING:** Do not use a vegetable base oil to lubricate bike pars. This type of oil may dry and leave a harmful gum residue.

**WEEKLY:** Wipe bike with a damp cloth. Wipe dry. Polish metal surfaces. On caliper brake models, do not polish rims. Make sure no oil gets on caliper brake shoes. With a spray lubricant, lubricate chain and rear sprocket. On caliper brake models, lubricate hand brake lever cable pivot points. Wipe seat with a damp cloth and wipe dry.

**ANNUALLY:** The following components require lubrication, removal, disassembly, installation, special tools and knowledge. It is suggested that this service be preformed by a qualified bicycle repairman. Caliper brake cables should be removed from housing and greased. Clean and lubricate wheel bearings, head bearings and crank bearings. Check spokes and wheels and have trued if out of line.

Before you ride this bicycle, read the Rules For Safe Cycling and check that all parts are installed as per this instruction manual. It is also recommended for added safety and protection that you wear a bicycle helmet.

If you understand how the bicycle operates, you will get the best performance. When you read this instruction book, compare the illustrations to the bicycle. Learn the location of all the parts and how they work. Keep this book for future reference.

Before you ride the bicycle, check the brake and other parts of the bike. Make sure all the parts are assembled correctly and working properly. Take your first ride in a large, open level area. If you have a problem, check the assembly instructions and follow the maintenance procedures in this book.

**WARNING ON AND OFF ROAD CONDITIONS:** The condition of the riding surface is very important. If the surface is wet, or has sand, small rocks or other loose debris on the surface, carefully decrease the speed of the bicycle and ride with extra caution. It will also take a longer time and more distance to stop. Apply the brake earlier than normal and with less force to help keep the bicycle from sliding.

## RULES FOR SAFE CYCLING

- a) Observe all state and local traffic regulations, signs, and signals. Check with your local police on bicycle licensing and inspection, and where it is legal to ride your bicycle.
- b) Stay on the RIGHT SIDE and always ride with the flow of traffic. Never ride two abreast-single file only. Watch out for opening car doors or cars.
- c) Do NOT ride at night. Vision is quite limited at dawn and dusk.
- d) Give pedestrians the right-of-way. Don't ride too close to pedestrians, and don't park your bicycle where it can get in the way.
- e) Avoid road hazards which may hinder your ability to control your bicycle. Potholes, ruts, uneven pavement, railroad crossing, manhole covers, storm grating, soft road edges, gravel, curbs, speed bumps, leaves, puddles, and debris can all have effect on your riding and result in loss of control.
- f) Never carry passengers on your bicycle. Never carry packages in your hands or attach anything to your bicycle which could hinder your vision or control.
- g) Don't play in the streets. Use caution at intersections.
- h) Don't wear anything that restricts your hearing.
- i) Always ride with both hands on the handlebars.
- j) Don't wear extremely loose clothing which could hang down and get caught in the wheels of your bicycle. Wear a cuff band or trouser clip to keep your pants from getting caught in the chainwheel.
- k) Always wear proper safety equipment. A helmet, long sleeved shirt, long pants, shoes, and elbow and knee pads are suggested. Gloves and eye protection also make good sense.
- l) Cover your stem, handlebar, and top tube with safety pads for additional protection.
- m) Do not ride bicycle if chain cover is not attached.

**ALWAYS WEAR A HELMET -  
IT COULD SAVE YOUR LIFE!**



Correct



Incorrect



## REPLACED WITH DETAILS

NOTE: There are many types of bike frame styles. Your bike may look slightly different from this illustration.

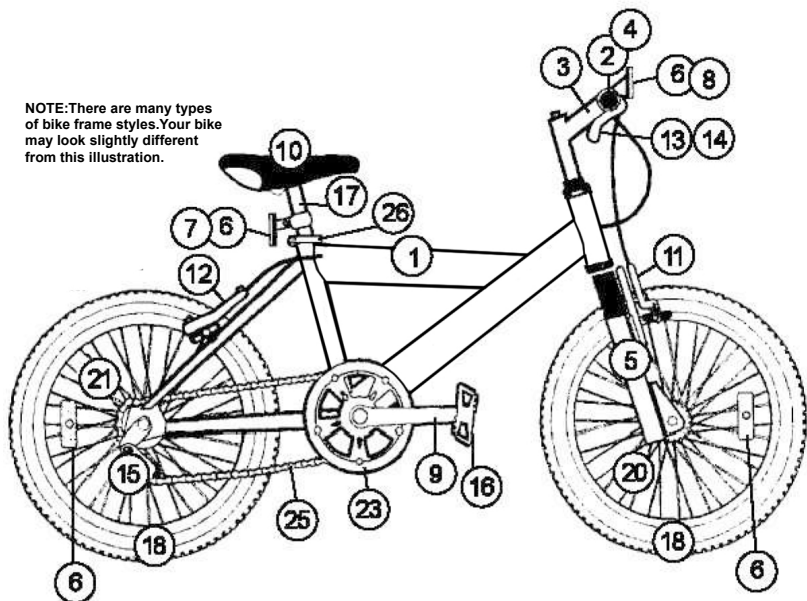

No.	PART DESCRIPTION	No.	PART DESCRIPTION	No.	PART DESCRIPTION
1	Frame	10	Seat	19	Front or Rear Inner Tube
2	Gris and Plugs	11	Front V-Brake	20	Front Wheel
3	Handlebar Stem	12	Rear V-Brake	21	Rear Wheel
4	Handlebar	13	Right Brake Lever	22	Shifter
5	Suspension or Rigid Fork	14	Left Brake Lever	23	Front Sprocket and Guard
6	Reflectors and Hardware	15	Rear Derailleur	24	Rear Sprockets
7	Rear Reflector Bracket	16	Pedals	25	Chain
8	Front Reflector Bracket	17	Seat Post	26	QR Seat Post Clamp
9	Crank Arms	18	Front Or Rear Tire	27	Kickstand

## 12 MONTH WARRANTY

**Thank you for your purchase from Kmart.**

**Kmart Australia Ltd** warrants your new product to be free from defects in materials and workmanship for the period stated above, from the date of purchase, provided that the product is used in accordance with accompanying recommendations or instructions where provided. This warranty is in addition to your rights under the Australian Consumer Law.

Kmart will provide you with your choice of a refund, repair or exchange (where possible) for this product if it becomes defective within the warranty period. Kmart will bear the reasonable expense of claiming the warranty. This warranty will no longer apply where the defect is a result of alteration, accident, misuse, abuse or neglect.

Please retain your receipt as proof of purchase and contact our Customer Service Centre on **1800 124 125 (Australia)** or **0800 945 995 (New Zealand)** or alternatively, via Customer Help at [Kmart.com.au](http://Kmart.com.au) for any difficulties with your product. Warranty claims and claims for expense incurred in returning this product can be addressed to our Customer Service Centre at **690 Springvale Rd, Mulgrave Vic 3170**.

Our goods come with guarantees that cannot be excluded under the Australian Consumer Law. You are entitled to a replacement or refund for a major failure and compensation for any other reasonably foreseeable loss or damage. You are also entitled to have the goods repaired or replaced if the goods fail to be of acceptable quality and the failure does not amount to a major failure.

For New Zealand customers, this warranty is in addition to statutory rights observed under New Zealand legislation.

## FLIP FLOP REAR HUB

**IF your bike is equipped with a flip flop hub, please read the information below.**

Your bike has been equipped with a very unique feature, a "flip flop" or double sided hub. A flip flop hub has sprockets on either side of the hub, there is a fixed gear sprocket on one side and a single freewheel on the other side.

When you purchase your bike the fixed gear sprocket will be on the right (chain) side of the bike. Most of the time you will use the fixed gear but if you find yourself tired of the constant pedaling, simply flip the wheel and use the freewheel.

There are two benefits from using the freewheel:

1. The lower gear will make it easier to climb hills.
2. The freewheel will let you coast on descents.

**WARNING: IT IS VERY IMPORTANT TO USE THE FRONT AND REAR BRAKES WHEN THE FREEWHEEL IS USED.**

### How to flip the wheel.

1. Remove the axle nuts from the rear axle.
2. Slide the wheel forward so that the axle is free of the frame dropouts, and slip the chain off of the rear sprocket.
3. Flip the wheel around and slide the chain onto the new sprocket.
4. Slide the wheel back into the frame dropouts, until the axle is in the proper location and the chain is tight.
5. Attach the axle nuts and tighten securely.

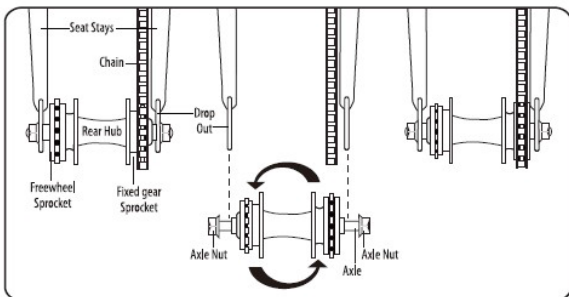

## WATER BOTTLE CAGE ASSEMBLY

**If your bike comes with predrilled holes:**

1. Line up the cage bracket with the holes and insert the allen head screws.
2. Tighten screws securely.

**If your bike does NOT come with predrilled holes:**

1. Shape clamp around bicycle tube.
2. Insert screw through holes in clamp and secure loosely.
3. Slide bottom tab of waterbottle cage bracket under clamp.
4. Tighten screw securely.
5. Shape second clamp around tube and over top tab of waterbottle cage bracket.
6. Insert screw and tighten securely.

**WARNING: When using clamp assembly. Make sure the clamps do not go over any cables or interfere in the operation of the bike in any way.**

